

# Intelligent Building Solutions

## Installation Manual



### **CHB 23 B NETWORK HUB**

- up to 8 BUS lines
- Desktop

**CIB-tech**

# Introduction

The CHB 23 B is an 8-channel CIB-tech network component, with the purpose of extending the maximum length of the CIB-tech network and simplifying the CIB-tech wiring by facilitating star-type topologies. It connects the backbone bus of the CIB-tech network and up to 8 different CIB-tech bus lines<sup>1</sup>.

## Technical Specifications

### Electrical characteristics

#### ● Power Supply

The CHB 23 B can be powered from two sources: remotely from the backbone cable of the CIB-tech network via the IBB-bus connector or locally through its power jack connector. The CHB 23 B favors local power supply over remote power and uses it automatically if available; should the local power supply fail, the CHB 23 B switches back automatically to backbone-supplied power. It should be noted that this is not a desirable scenario unless the network is designed to be backbone-powered in the first place, since the increased load on the backbone cable may lead to insufficient voltage on the network section connected to the inadvertently remote-powered hub and / or may cause overheating of the backbone cable itself.

- Operating voltage range: 20 to 28V DC (nominal 24V DC)
- Own power consumption (no hub-powered network segments connected)
  - Power supply via IBB-bus connector
    - Standby current ( $I_{HS1}$ ) 40mA
    - Maximum current ( $I_{HM1}$ ) 65mA
  - Power supply via dedicated power jack
    - Standby current ( $I_{HS2}$ ) 50mA
    - Maximum current ( $I_{HM2}$ ) 80mA

#### ● Power output

- Output voltage = Input voltage – 0.3V
- Maximum output current:
  - Via backbone bus connector ( $I_{BBM}$ ) 3A
  - Via bus connectors, each ( $I_{BM}$ ) 400mA

Power consumption of a hub is a function of the requirements of the network segments it is itself supplying with power and can be found as the sum of all the network's and its own power consumption. At full load on all segments, including power for other hubs via the output backbone connector (OBB), this would become:

$$I_{HUBM1} = I_{HM1} + I_{BBM} + 8 \times I_{BM} = 6.265A \text{ for remotely powered hubs (via IBB) or}$$
$$I_{HUBM2} = I_{HM2} + I_{BBM} + 8 \times I_{BM} = 6.28A \text{ for locally powered hubs}$$

However, if the hub is remotely powered from another hub via the backbone, its  $I_{HUBM}$  cannot exceed the output power rating of the hub that powers it ( $I_{BBM}$ ), therefore such a remotely powered hub may not be loaded to its full load. For such a hub, the sum of all the power it's expected to deliver and consume must be less than the amount of power available to it ( $I_{BBM}$ ):

$$I_{HUBM1} = I_{HM1} + I_{BB} + I_{B1} + I_{B2} + I_{B3} + I_{B4} + I_{B5} + I_{B6} + I_{B7} + I_{B8} < I_{BBM}$$

Locally powered hubs have no such limit and can be loaded to the maximum rating of their backbone and bus outputs.

<sup>1</sup> See "CIB-tech installation manual" for details.

## Mechanical characteristics

The CHB 23 B has a beige, flat, desktop-type enclosure.

- Dimensions: 145mm W x 190mm L x 31mm D
- Weight: 315g

## Environmental characteristics

- Operating temperature: -10°C to 85°C
- Storage temperature: -25°C to 100°C

## Key Features

- Connects backbone with up to 8 bus lines
- Can be powered via backbone bus connector or via dedicated power connector
- Provides power via the bus lines to the connected devices
- Can provide power to other CIB-tech hubs
- Internal power LED (active for both remote or local power)

## Installation

The CHB 23 B is a desktop hub that requires no special mounting; it can be placed in any suitable rack cabinet or junction box at the CIB-tech bus junction.

### Part description

- **Bus connectors:**
  - 4P4C modular jack connectors for connecting CIB-tech bus lines (other CIB-tech devices)<sup>1</sup>
  - The CHB 23 B has 8 (B1 to B8) functionally identical bus connectors
- **BUS EOL switches:**
  - End Of Line switches for CIB-tech bus lines
  - every BUS EOL switch corresponds to the bus connector above it
- **IBB bus connector:**
  - “Input backbone bus connector” - 8P8C (RJ45) modular jack connector for connecting the CHB 23 B device to the backbone of the CIB-tech network
  - A CHB 23 B device can be powered remotely via this connector
- **OBB bus connector:**
  - “Output backbone bus connector”- 8P8C (RJ45) modular jack connector for connecting the CHB 23 B device to the backbone of the CIB-tech network
  - Power can be delivered to other CIB-tech devices (mostly other hubs) via this connector
- **BB EOL switches:**
  - End Of Line switches for the CIB-tech system's backbone bus<sup>1</sup>
- **LED:**
  - Power-on LED
- **Power switch:**
  - main power switch for the CHB 23 B. This switch enables/disables powers for the CHB 23 B and the bus lines; Note that the OBB bus is always powered, it dose not depend on power switch state
- **Power connector:**
  - 2.1mm female power jack connector for main power supply (if the device is powered via this connector it disconnects from the IBB bus supplied remote power)

<sup>1</sup> See “CIB-tech installation manual” for details.

- **Selector switch:**
  - rotary switch for changing bus timing (see details below)

### CHB 23 B front view

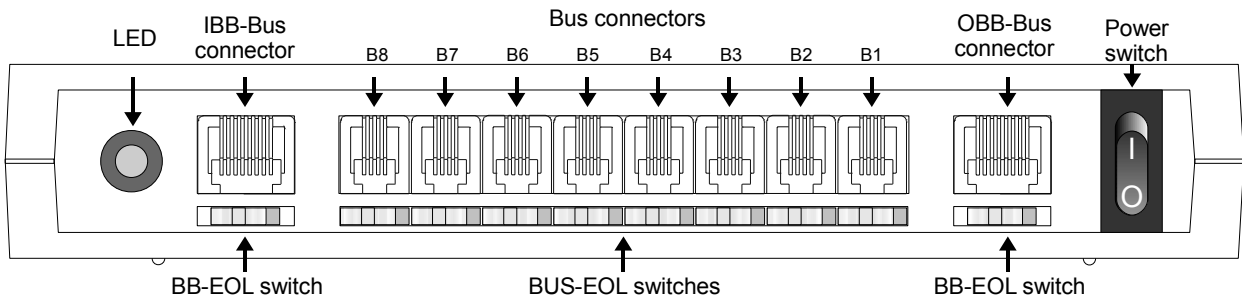

### BUS-EOL switch / BB-EOL switch



### CHB 23 B rear view

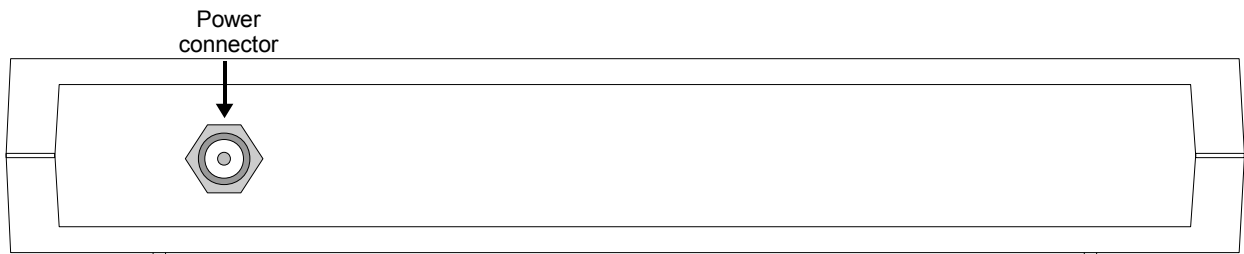

# CHB 23 B top view

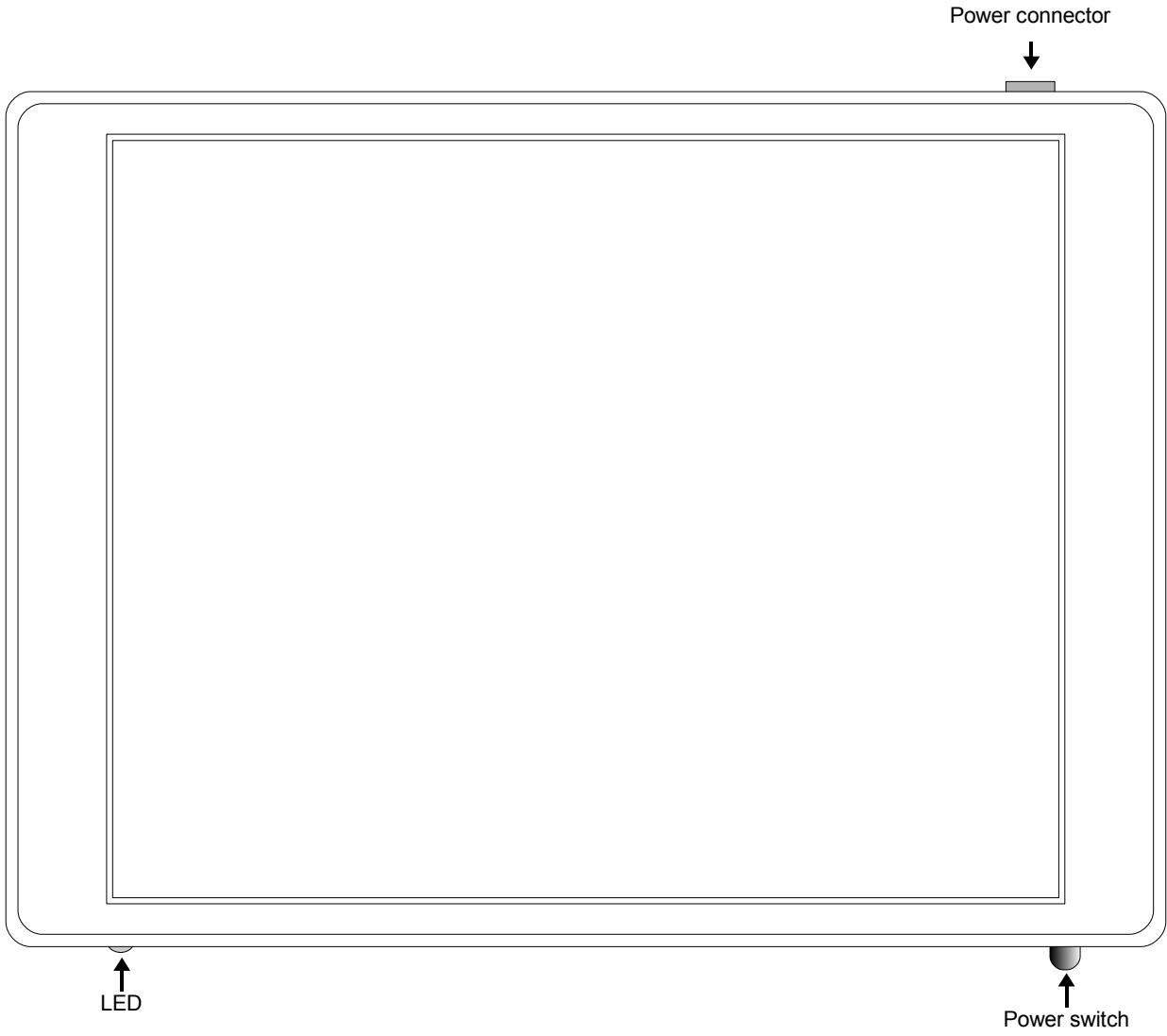

## CHB 23 B bottom view

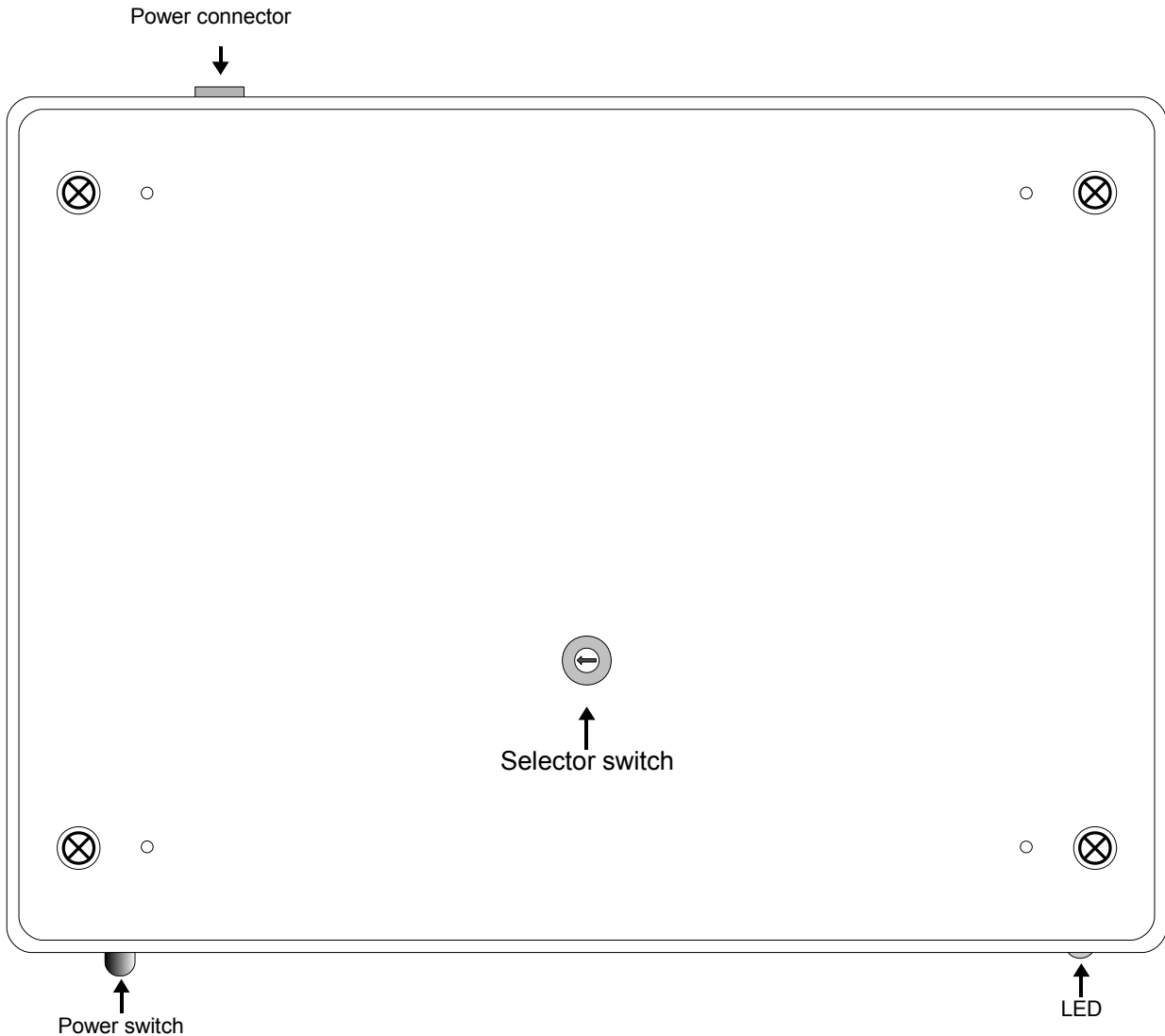

### Wiring diagrams

Connection to the backbone bus of the CIB-tech system:

Use the CHB 23 B device's two 8P8C (RJ45) modular jack connectors to connect it to the CIB-tech systems (chain like) backbone bus. Do not forget to switch off the corresponding BB-EOL switch(switches) if other devices/hubs are connected to the IBB bus and / or OBB bus connector<sup>1</sup>; Please note, however, that an IBB bus connector should only be connected to another hub's OBB bus connector, and so on. Connecting an IBB bus connector to another IBB bus connector is allowed if none of the two hubs are to be remotely powered, but you should **never** connect two OBB bus connectors with each other.

**NOTE:** In small CIB-tech systems installations, where no backbone is present (the CHB 23 B is not connected to other hubs) the BB bus connectors are not used and the BB-EOL switches must be in the ON position.

<sup>1</sup> See "CIB-tech installation manual" for details.

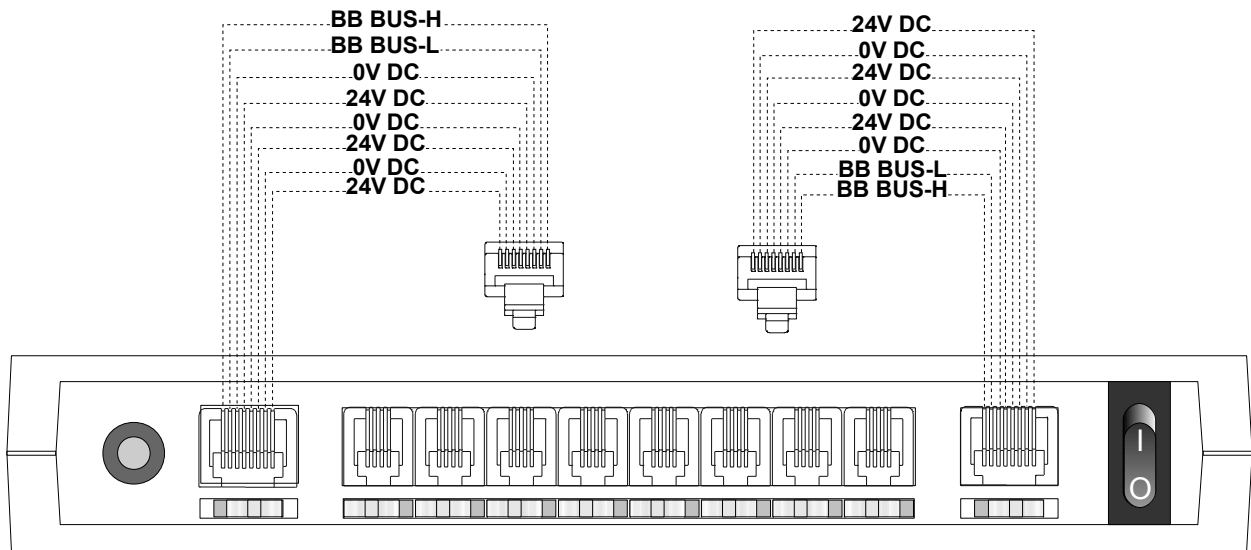

### Connection to CIB-tech systems bus lines (other devices):

Use the CHB 23 B device's 8 4P4C modular jack connectors to unite up to 8 CIB-tech bus lines into one CIB-tech network, connected with other bus lines of other hubs via the backbone;

Please do not forget to set the BUS-EOL switches correctly. All the bus connectors that have a bus line connected to them should have their switches in the OFF position. All the other switches, corresponding to unused bus connectors, should be in the ON position.

Please check the power consumption of the individual bus lines: the maximum power output supplied by each 4P4C connector on the CHB 23 B device is 400mA at 24V.

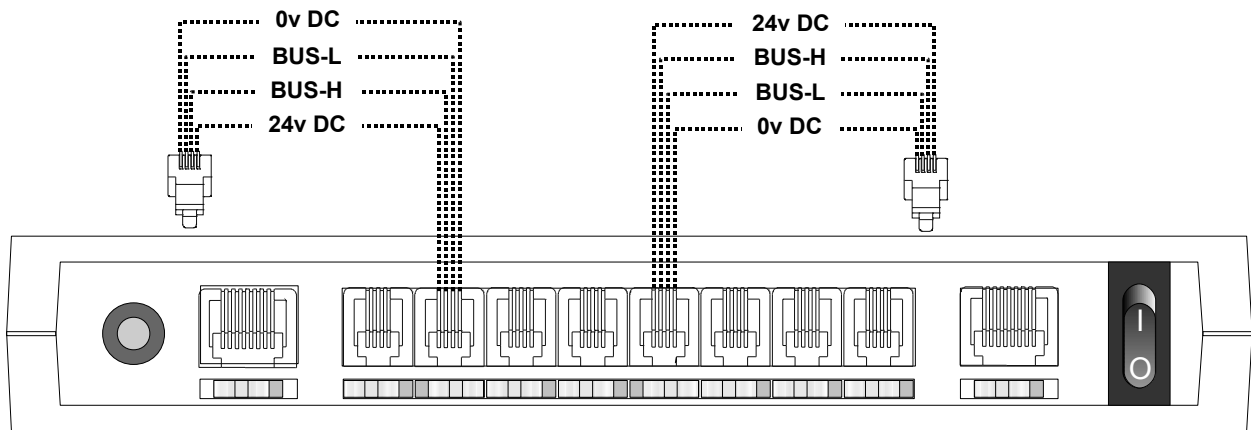

**NOTE:** No other CIB-tech hub should be connected to the bus lines.

## Connecting the power supply

The CHB 23 B can be powered via its local power connector:

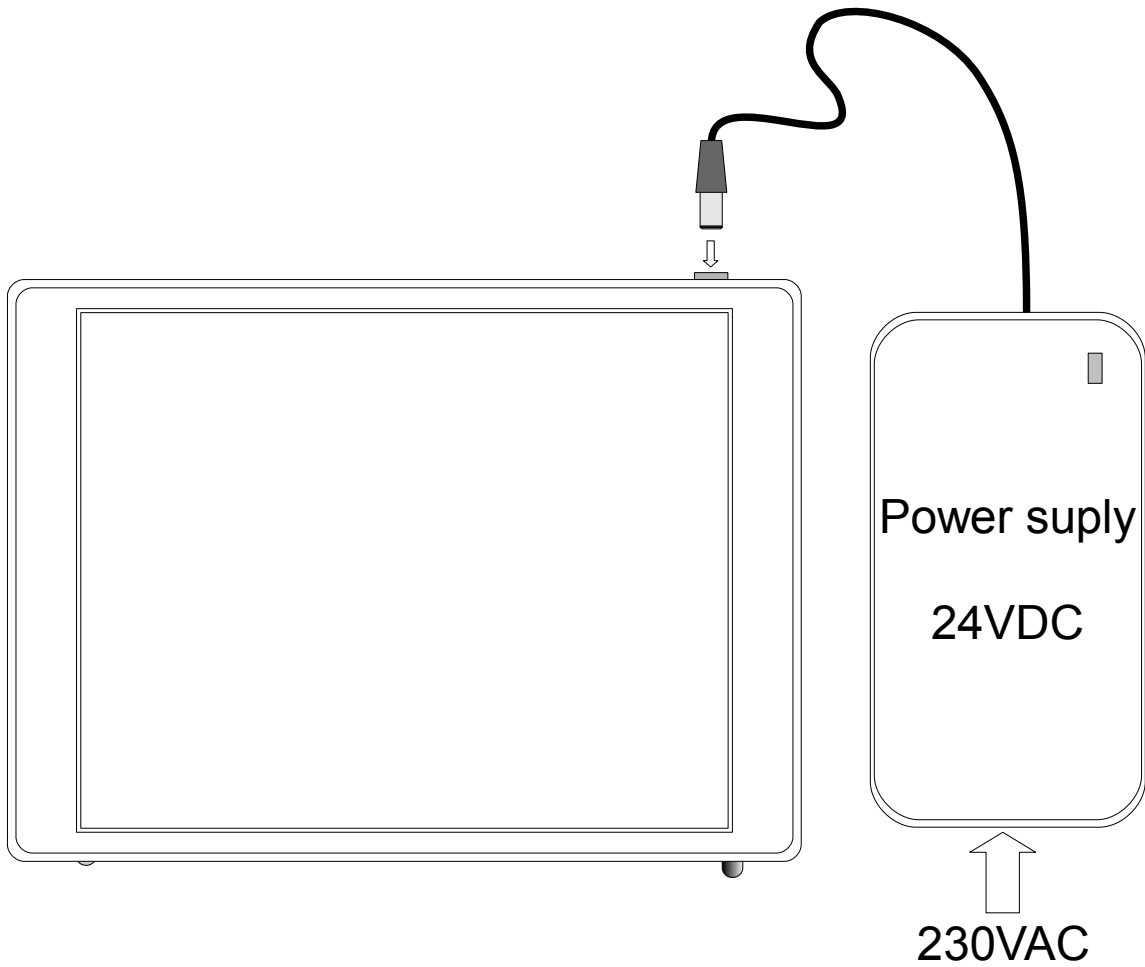

**NOTE:** Power supply with  $\Phi 5.5 \times \Phi 2.1$ mm DC plug is required<sup>1</sup>.

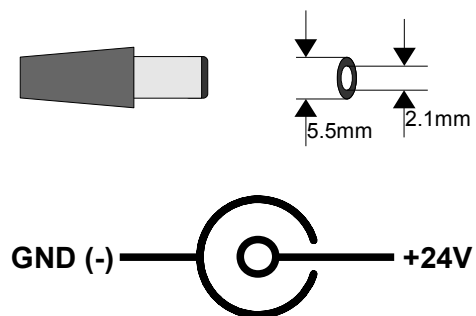

<sup>1</sup> See "Recommended equipment to be used with CIB-tech" for details



## Adjusting bus timing

To insure correct operation of the CIB-tech network, the CIB-tech hubs have a built-in timing circuit used to counter the effects of bus capacitance and end-of-line signal reflections. The factory default setting should be adequate in most cases, but signal quality depends on actual cabling circumstances and in case of poor bus performance the timing might need adjustment.

Changing bus timing is possible using the timing selection switch located on the bottom of the CHB 23 B. The CHB 23 B's timing selection switch has 16 positions, marked 0 to 15(F), with hexadecimal numbers. The typical values in use are 3 to 7 with the default value of 4. Values outside of this range should only be used in extreme cases, 0 is factory reserved and should never be used.

**NOTE:** Before changing the default setting be sure that you understand the terms in the “CIB-tech Installation Manual” or contact IBS tech support.

## Setting the selector switch

Use a small screwdriver to rotate the selector switch to the desired value (pointed-to by the arrow-shaped tip of the switch):

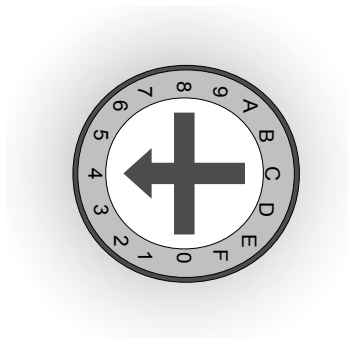

Document Version 1.0

Technical Support:  
<http://www.ibs-smarthouse.com/>  
[info@ibs-smarthouse.com](mailto:info@ibs-smarthouse.com)

All trademarks used in this document are properties of their respective owners.  
[The manufacturer reserves the right to change the technical features of this product without prior notice.](#)